



NEW SMART CITY KEY OBJECTS

smartKo

NEXT GENERATION SMART KIOSKS

RELEASE #1



NEW SMART CITY KEY OBJECTS

NEW SMART CITY KEY OBJECTS
smartKO

To keep up with the digital revolution, new key objects will be absolute musts for the city of the future, i.e. innovative structures designed to support the many technologies that will improve citizens' urban experience, in turn, making the cities smarter yet more sustainable and attractive. This is the aim of **SmartKO**.



EdiKO / HubKO



VertiKO



QatafTower

THE NEW GENERATION OF SMART KIOSKS



Understanding that technology and innovation are man's best friends and fully reaping the benefits deriving from their large-scale diffusion. In fact, **SmartKO** has developed a range of digital kiosks for the city of tomorrow with this concept in mind: **EdiKO**, **TouristKO**, **TicketKO** and **HubKO**. Attractively-designed modular architectural structures which, thanks to cutting-edge technology, smartly combine information, communication, functionality and services, whilst distinctively establishing themselves as a new everyday reference and meeting point.



EdiKO
The new era of news kiosks that have been transformed from cultural outposts into multifunctional hubs..



TouristKO
Equipped with the most advanced technology to provide information to tourists and citizens alike.



TicketKO
Multifunctional ticket offices that sell public transport tickets, in addition to those for upcoming exhibitions, fairs and events.



HubKO
The data collection and security management-focused monitoring centre.

SMART CITY FUNCTIONALITY

The **SmartKO** digital hubs have been designed both to improve life in the cities of the future - by rationally incorporating the main services that the modern citizen may ever need into a single structure with a highly distinctive design - and to allow new business models to be developed by opting to rent out third-party spaces and technologies.



Neutral hosting & Edge Computing

SmartKO's multifunctional smart kiosks can house computers and devices, in turn, allowing the manager to develop its space-renting business by setting up various technologies, such as:

- 5G small cell antennas for the latest-generation connectivity
- City Wi-Fi access points
- Mission-critical communication equipment for law enforcement agencies
- IoT gateway for connecting Internet of Things devices

Special spaces have been designed to host computing resources for locally-produced data processing purposes:

- **Telecommunications:** 5G radio equipment for network virtualisation, content caching and lag minimisation.
- **Videosurveillance:** video analysis and artificial intelligence equipment able to identify and classify events and objects.



Digital Signage and Digital Services

By opting to integrate LED displays and touchscreens, the **SmartKO** structures will become reference points for citizens and tourists alike:

- **Digital services:** the touchscreens allow users to interact and access an infinite number of digital services.
- **Infotainment:** the displays feature tourist, commercial or other information.
- **Digital Signage:** the external walls have been designed specifically for selling advertising space.



Urban security and video surveillance

Urban centre safety is an essential factor as far as the quality of life of citizens is concerned. Therefore, the multifunctional hubs become strategic tools for widespread area control and urban security.

- **Drone in a box:** the structure's roof features a built-in drone landing platform which allows for the local area to be patrolled and public safety-related videos and images to be recorded.
- **Videosurveillance:** video streams from the integrated CCTV cameras are used for people monitoring and automatic event classification purposes.
- **Acoustic sensors:** special acoustic sensors recognise gun shots, screams and other noises, and will set off the alarms in the event of any attempted theft and vandalism of the structure itself.

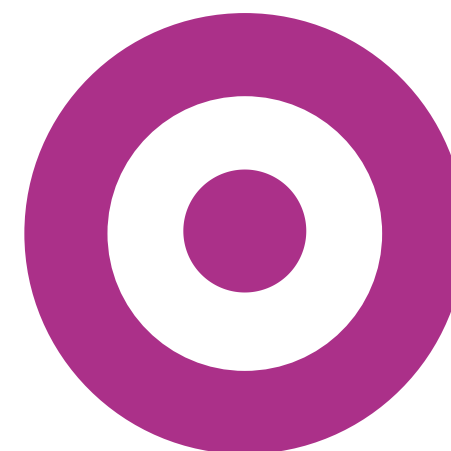

FUNCTIONAL AND ECOSUSTAINABLE

The new generation of SmartKO digital kiosks has been designed to improve the quality of life in the cities of the future, by elegantly integrating technologies with a strong emotional impact: those that allow for energy savings, in addition to those that reduce pollution by promoting cleaner and more efficient modes of transport



Environmental monitoring

The SmartKO structure-integrated environmental sensors allow for data collection and the pollution level to be monitored; an essential activity as far as citizen well-being is concerned.

- **Meteorological data:** temperature, relative humidity and atmospheric pressure.
- **Air quality data:** particulate matter (PM2.5 and PM10), ozone (O3), nitrogen dioxide (NO2), sulphur dioxide (SO2) and carbon monoxide (CO) emissions.



Sustainability and green mobility

SmartKO's multifunctional smart kiosks are sustainable structures designed to promote sustainability in the Smart City of tomorrow:

- **Clean energy:** the roof-installed [photovoltaic panels](#) are able to meet some of the structure's energy needs.
- **Green mobility:** charging stations - compatible with the most popular brands of [e-bike](#) and electric scooters - encourage green mobility.
- **Charging services:** USB charging stations allow for any USB device to be charged.



EdiKO



SmartKO transforms news kiosks into highly-attractive multifunctional centres, which will allow newsagents to develop their business by aiming to satisfy all of the modern citizen's needs. They can do so by offering multiple services, such as registry, postal, parcel delivery and information search-related services; all of which have become increasingly vital for everyday life. A genuine hub that smartly rationalises and incorporates all the technological elements that are sometimes scattered throughout our cities in just a single structure with an ultra-refined design.

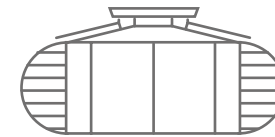

THE NEWS KIOSK: FROM CULTURAL OUTPOST INTO MULTIFUNCTIONAL HUB



An architectural element that adds a distinctive touch to its urban surroundings. A reference and meeting point for the local area. The link between information and citizens. A discovery-filled place. The new daily routine. A news kiosk is much more than just a business. It is a beacon whose light is fading due to this technology-redefined market, new consumer habits and an ever-evolving society.

SmartKO's goal is to rewrite the uncertain fate of news kiosks by projecting them into the future. By breathing new life into them, reinterpreting them in an avant-garde manner and transforming them into truly multifunctional spaces, able to meet the connectivity, digitalisation and sustainability demands of modern citizens and urban settings. Thanks to **SmartKO**, the future is already here.

EXTERNAL MODULES



Curvilinear panel with LED screen (single side) or backlit image (both sides).



Module with LED screen or backlit image.

INTERIOR MODULES



Module with steel and glass panel for magazines/books.



Module with 65" screen and painted steel object holder panel.



Module with painted steel bookcase.

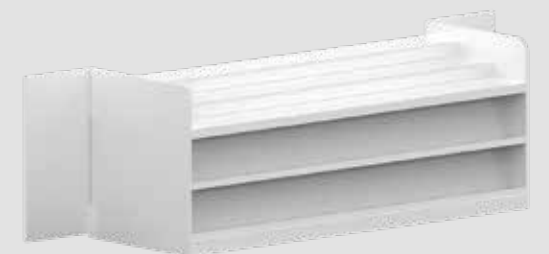

FURNITURE

Painted steel counter for magazines/books with cashbox and PCs.

HubKO



The modular and customisable **SmartKO** digital kiosks have been designed to house a real store – such as a news kiosk – or accommodate monitoring, management and control workstations and displays. **HubKO** is our smart kiosk solution to a digital hub; it serves to control and manage Smart City products and promote sustainable mobility through the installation of an e-station that can charge electric pedal-assist bikes and electric scooters.

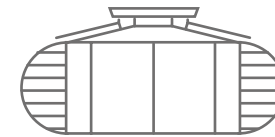

MULTIFUNCTIONAL HUB FOR SUPERVISION AND CONTROL



Video surveillance management by means of video analysis. Access control and management. The new “intelligent” approach that uses IoT technologies to smartly manage buildings, lighting and waste. All this makes collecting information from various assets increasingly important. The **SmartKO** digital hubs are monitoring and control

centres from which data can be monitored, recorded and processed not only for security purposes, but with the aim of reducing costs, eliminating waste, increasing profits and providing the option to quickly manage any malfunctions or adopt predictive maintenance procedures.

EXTERNAL MODULES



Curvilinear panel with LED screen (single side) or backlit image (both sides).



Module with LED screen or backlit image.

INTERIOR MODULES



Module with steel and glass panel for magazines/books.



Module with 65" screen and painted steel object holder panel.



Module with painted steel bookcase.

FURNITURE



Painted steel multifunctional meeting table with connections for PCs.

INTELLIGENT AND MODULAR

The **SmartKO** digital kiosks boast a modular prefabricated structure that has been designed to integrate perfectly into modern urban settings whilst meeting all space and functionality requirements. **The main element is the aluminium frame 240 cm high and 180 cm wide which, when combined with several units, gives rise to different configurations** with 6, 8, 10 or even 12 sides, in addition to a surface area ranging from 8 to 35 m². The frame has been designed to support modular panels on both the structure's exterior (LED displays and advertising panels) and interior (magazine racks, shelves, screens and more). Maximum versatility when it comes to aesthetics; in fact, the **SmartKO** multifunctional hubs can be customised with any desired finish.

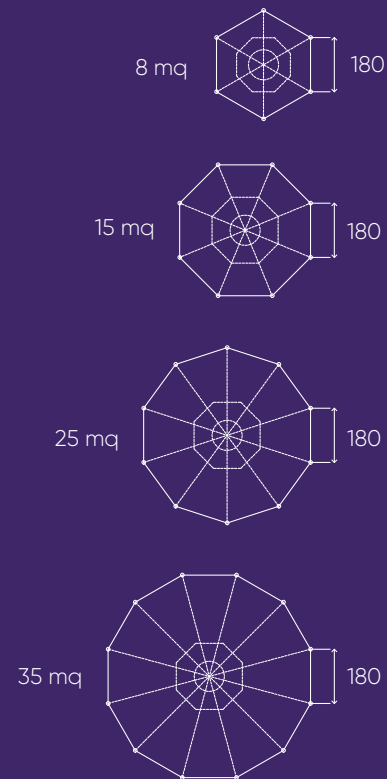
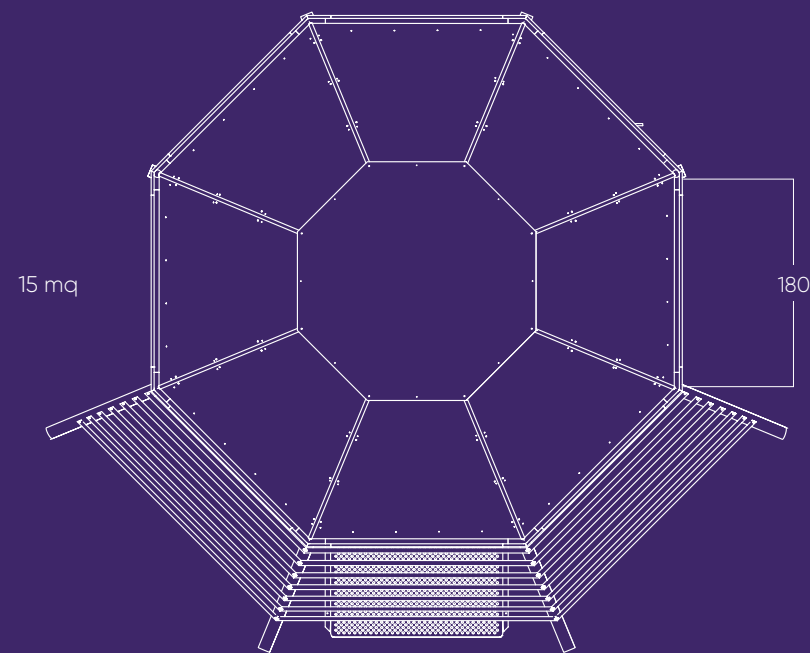
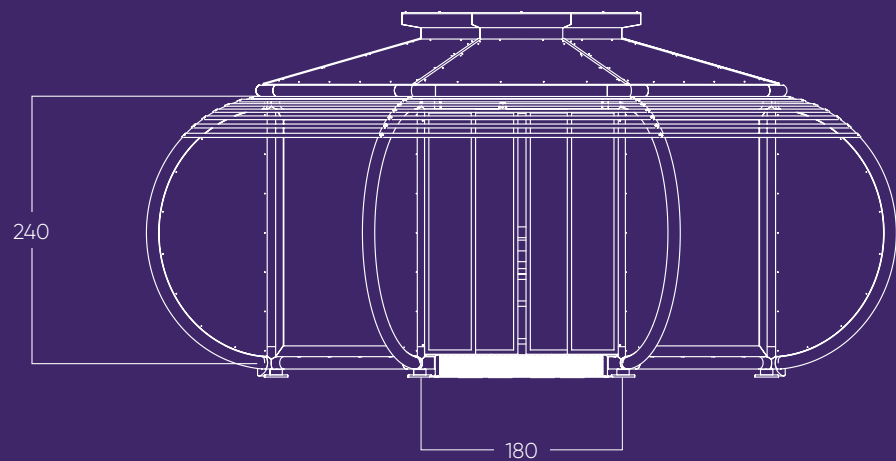

INDOOR

Steel and glass magazine rack

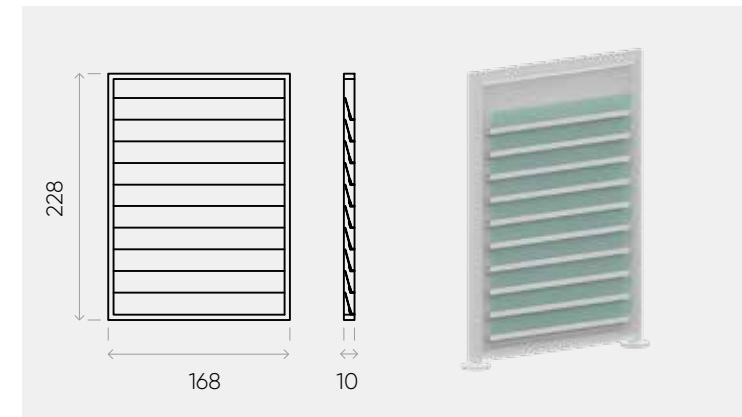

Painted steel storage bookcase

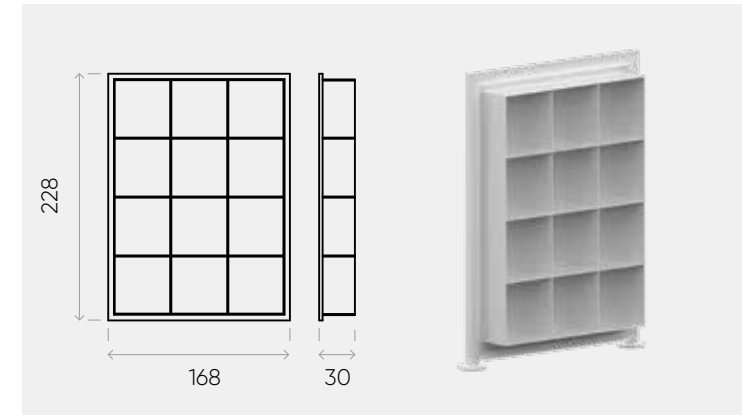

Panel with 65" screen and painted steel object holder

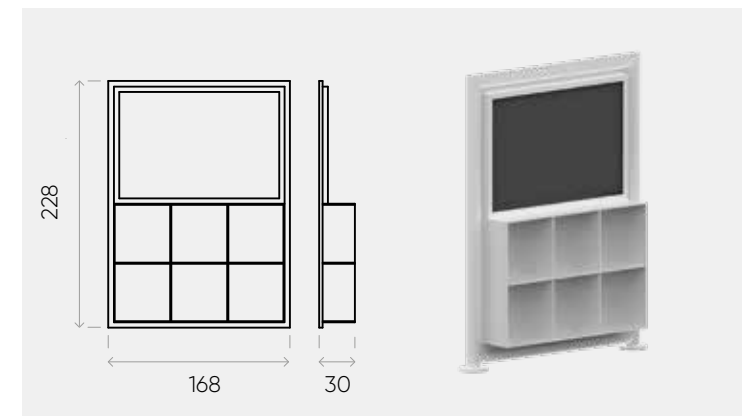

OUTDOOR

Panel with backlit image

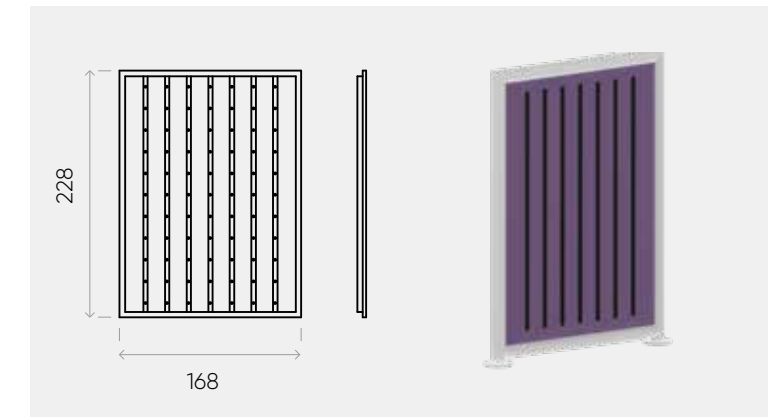

Outdoor LED screen

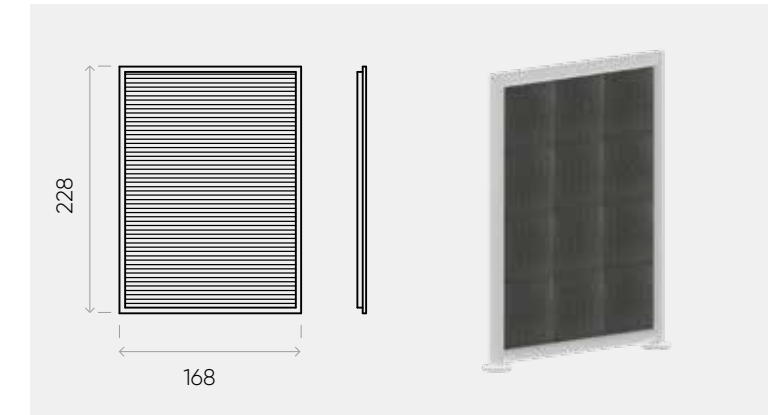

Curvilinear panel with LED screen (single side) or backlit image (both sides)

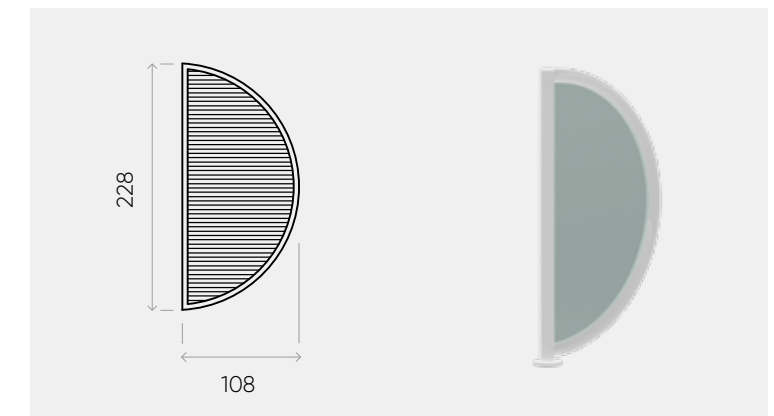

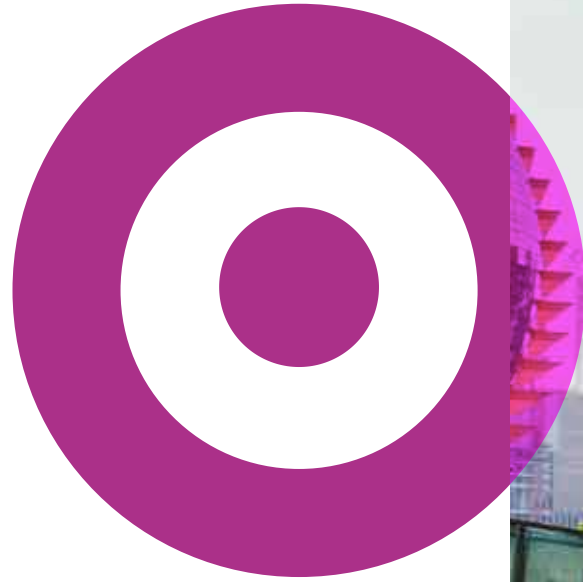

VertiKO



VertiKO's structure is 98% recyclable and protects the drone like a cradle. The hemispherical shell protects from wind, rain and snow, automatically opening before the aircraft take off and then closing again once the patrol service is finished. The holes in the base of the landing plate allow for perfect drainage. The luminous LED strip at the pole attachment allows night lighting of the area below. **VertiKO's** roof contains an innovative spherical photovoltaic technology capable of obtaining concentrated energy up to 200Wp for wireless charging of the drone.



SMART LANDING POLE FOR DRONES

The Smart Cities of the future need new control and management tools for the safety of public and private areas. Aerial control by means of video surveillance drones on intelligent poles represent the most innovative solution in the field of urban security. **VertiKO** is a **smart landing pole** that houses a video surveillance drone capable of patrolling in complete autonomy, 24/7,

private and public areas. Equipped with a sophisticated infrared HD video camera and connected in real time with the remote command center, the drone allows intelligent security management in multiple modes: it can be controlled by software or by a single operator in the front line, thus eliminating the need for professional pilots using traditional RC remote controls.



Qataf Tower



Qataf Tower aims to be the first high-design antenna tower able to communicate to the world Qatar's natural predisposition for technological innovation and a deep passion for beauty and art in view of the upcoming FIFA World Cup 2022.

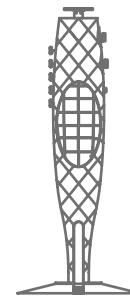

LARGE PROJECTS

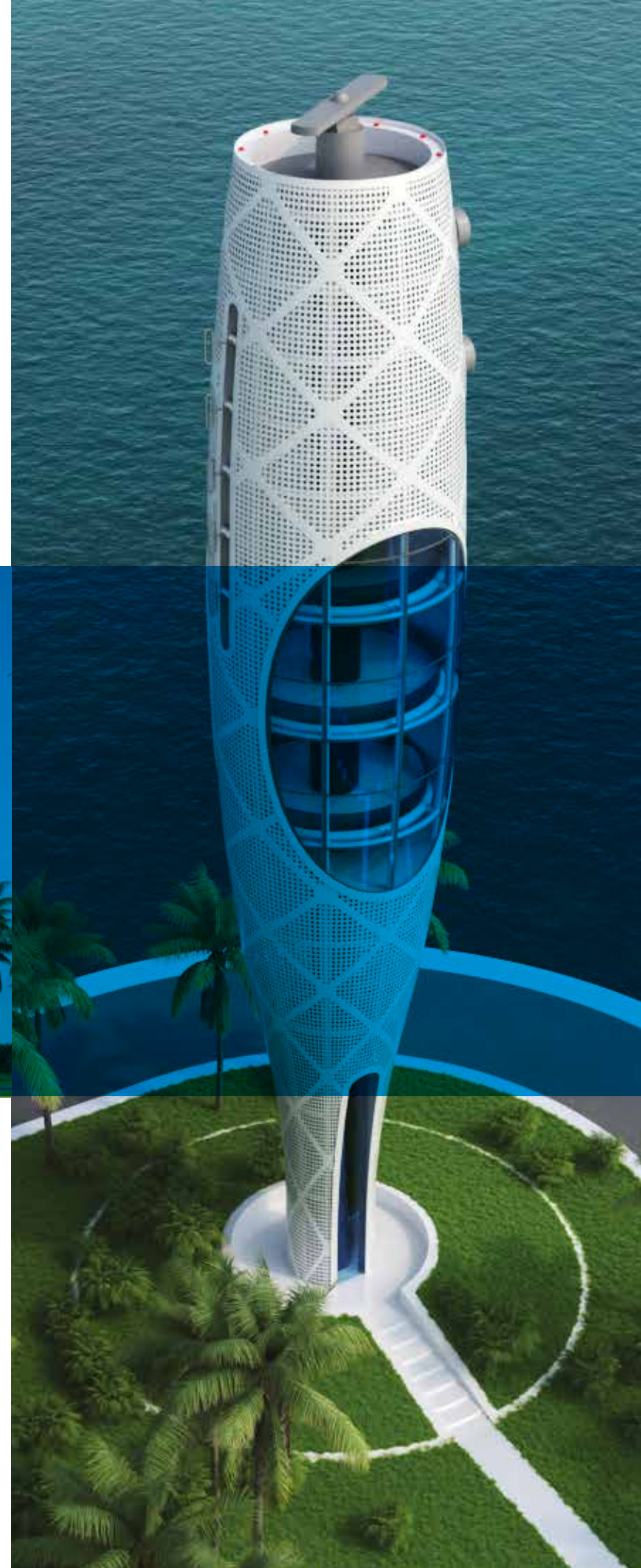

Qataf Tower is the project of an innovative tower-sculpture for radar control and 5G communications in the Cruise Ship Port of the artificial island of Doha in Qatar, in front of the waterfront, the Corniche that extends for seven kilometers along the Doha Bay. Designed by the architect Giancarlo Zema, the project is inspired by the shapes of the tapered bud of Qataf, the national flower

of Qatar that grows along the coast of the country and blooms from March to May. **Qataf Tower** is not just a technical tower equipped with antennas, but a magical place for observation and reflection, with its café, the bidirectional panoramic view at a height of 40 meters, and three walkable levels for a total area of 200 square meters.



OUR HISTORY IS IN THE FUTURE



SmartKO - Smart City Key Objects - is future and design-focused.

The company was founded on innovation-oriented services for citizens with the aim of developing technologically advanced and eco-sustainable solutions for the cities of tomorrow. Functional yet experiential projects and products, able to communicate with increasingly

exigent and evolved individuals, by satisfying their connectivity, interactivity and sustainability needs. This cutting-edge approach stems from the extensive expertise of the **Calzavara** group, a leader in the telecommunications industry-serving innovative infrastructure sector; the same industry in which **SmartKO** is active.

DESIGNER



Giancarlo Zema

SmartKO has relied on designer and architect Giancarlo Zema's creativity to breathe life into its emotion-evoking, highly innovative and high-design projects.

Giancarlo Zema was born in Rome in 1973, he graduated in architecture at the "La Sapienza" University of Rome, with professor Giovanni Zuccon, one of the most important naval architects on the international scene. After several international collaborations, in 2001 he founded the Giancarlo Zema Design Group (GZDG), an innovative architecture practice in Rome, specialized in smart eco-sustainable projects, semisubmerged architectural structures, floating habitats, yacht and interior design, competing with extraordinary hotel and resort projects on the water in Qatar and United Arab Emirates, pedestrian bridges in Bahrain, sports facilities in Libya and Azerbaijan, restaurant chains in Iran and vertiports in China. For ANAS, the public Italian highway company, architect Zema designs the "Green Island" smart charging stations for electric cars, distributed throughout the country, and the Smart Road

Center in Rome. For Luminexence, a brand owned by the Turkish MITAS Group, he signs innovative collections of solar-powered street furniture, completely off-grid, receiving important international awards. In the industrial design sector, he collaborates with important Italian companies including: Giovannetti, Runtal, Origami Furniture, Luxyde, SmartKO, iSpace2o, creating unique and emotional settings and objects for them. Giancarlo Zema is often a guest at conventions and television programs. Interviewed by the most important international magazines and newspapers in the architecture and design sector, The New York Times, The Sunday Times and Forbes have written about him. His projects are the subject of international exhibitions and exhibited by cultural institutions including La Triennale Milan Design Museum, The Venice Biennale, Ara Pacis Museum, Farnesina Design, that recognize his bold creativity and profound innovative strength. Such as today, he boasts over one hundred publications and numerous covers.



NEW SMART CITY KEY OBJECTS

smartKO

SmartKO is a Company of Calzavara SpA.

 **calzavara**

SmartKO Srl

Head Office: Via dei Mille 47, 80121 Napoli
Headquarters: via Corecian 60, 33050 Basigliano
T (+39) 0432 84 381
info@smartko.eu
www.smartko.eu